

INFORMATION FOR FIRST AND SECOND RESPONDERS

EMERGENCY RESPONSE GUIDE FOR VEHICLE

OUTLANDER PHEV

2020 Model year



Version:1.0

Introduction

This manual provides safety instructions that need to be followed when rescuing the passengers from the vehicle after an accident and describes how to handle the damaged vehicle.

Failure to follow these instructions and especially the warnings and cautions may result in serious injury such as an electrical shock due to the high voltage battery installed on OUTLANDER PHEV.

Please read and understand this manual carefully for your and the passengers safety.

Throughout this manual the words **WARNING**, **CAUTION** appear.

These serve as reminders to be especially careful. Failure to follow instructions could result in personal injury or damage to your vehicle.



WARNING

Indicates a strong possibility of severe personal injury or death if instructions are not followed.



CAUTION

Means hazards or unsafe practices that could cause minor personal injury or damage to the vehicle.

NOTE:

Gives helpful information.

*: indicates optional equipment.

It may differ according to the sales classification; refer to the sales catalogue.

Mitsubishi Motors reserves the right to make changes in design and specification and/or to make additions to or improvements in this product without obligation to install them on products previously manufactured.

- Please note that the contents of this manual may not fit completely with actual vehicle due to the change of vehicle specification.

CONTENTS

1. Identification / recognition	P.3
2. Immobilisation / stabilization / lifting	P.8
3. Disable direct hazards / safety regulations	P.9
4. Access to the occupants	P.13
5. Stored energy / liquids / gases / solids	P.16
6. In case of fire	P.17
7. In case of submersion	P.18
8. Towing / transportation / storage	P.19
9. Important additional information	P.22
10. Explanation of pictograms used	P.28

1. Identification / recognition

1. Features on vehicle exterior

Outlander PHEV shares one vehicle body with petrol engine models. Therefore, their exteriors are very similar. If you find any of the following features which can identify Outlander PHEV, always wear appropriate Personal Protective Equipment (PPE).

WARNING;

- Use insulating Personal Protective Equipment (PPE) (Rubber insulating gloves, Rubber soled insulating shoes: rated to a minimum of 400V voltage resistance), when contact with the vehicle body is possible, until you can identify whether the vehicle is Outlander PHEV or not.
 - Engine noise does not always mean that the vehicle is a model with petrol engine.
- You should refer to the feature list.

(1) Feature list

"PHEV (PLUG-IN HYBRID EV)" logo, battery charging lid, chassis number (model code), and power drive unit (PDU) cover

(2) Features on exterior

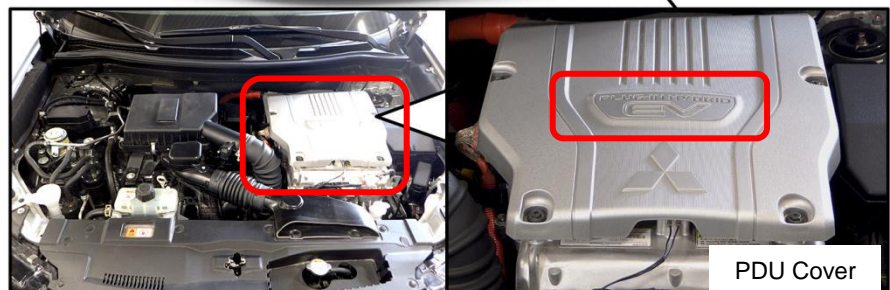
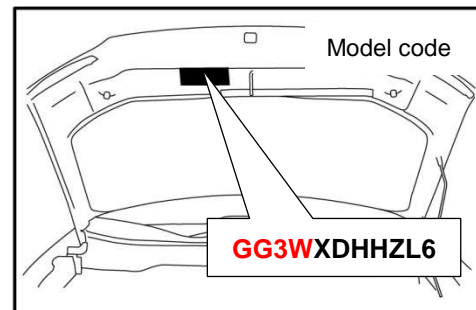
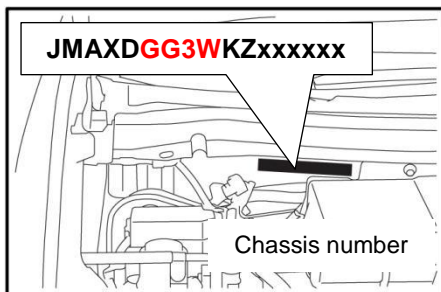

**OUTLANDER
PHEV**

**PLUG-IN HYBRID
EV**

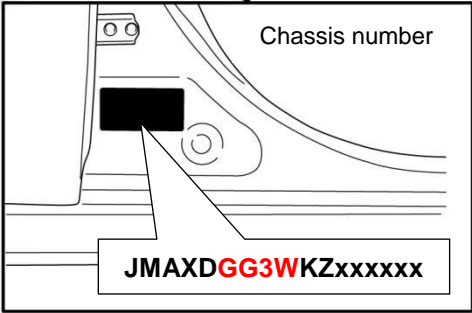
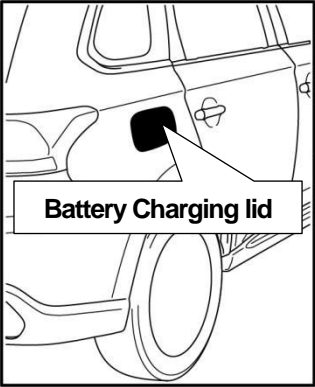

2. High voltage wiring harness location

High voltage wiring cables are located as shown in the figure below.

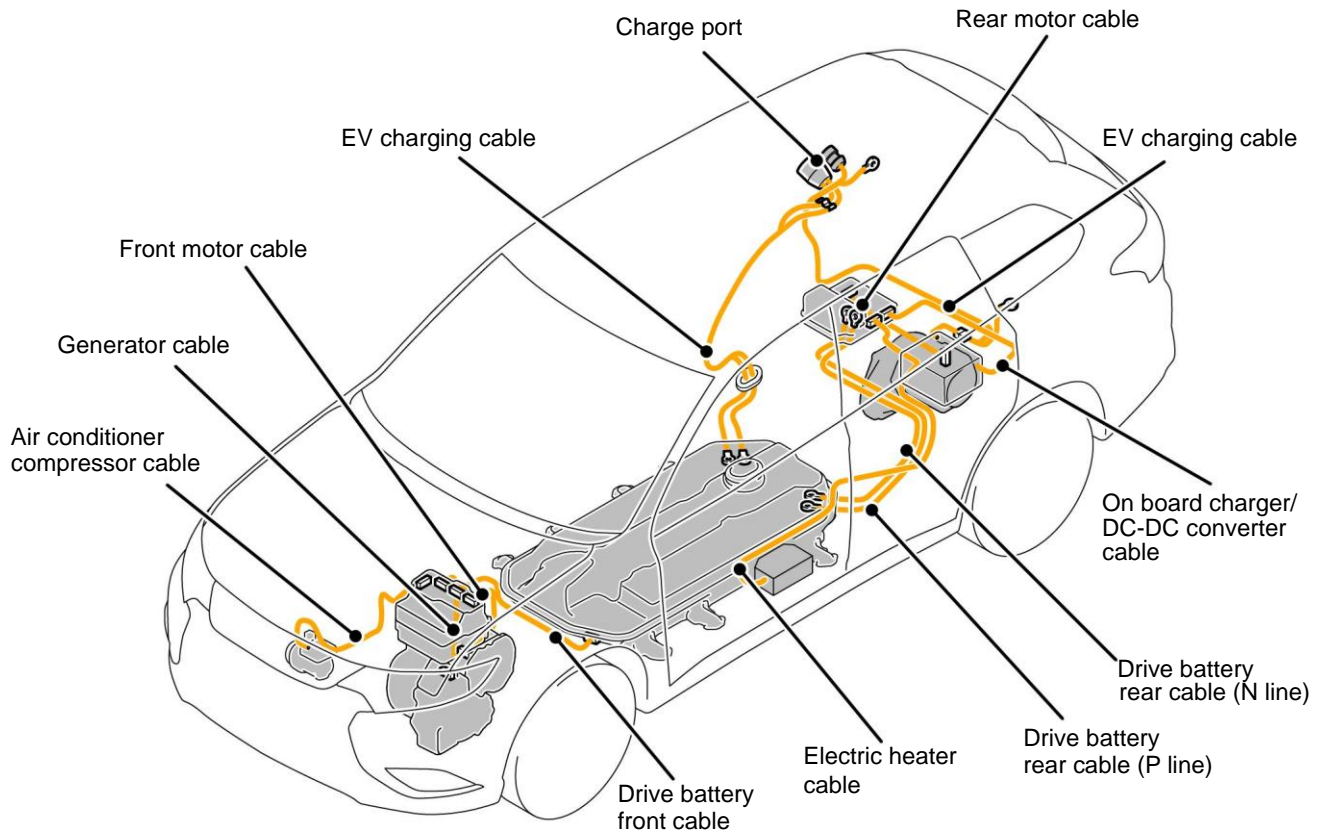

*: Refer to "10" for the explanation of pictogram

3. SRS airbag component location

SRS airbags system (location of airbags and related components) are located as shown in the figure below:

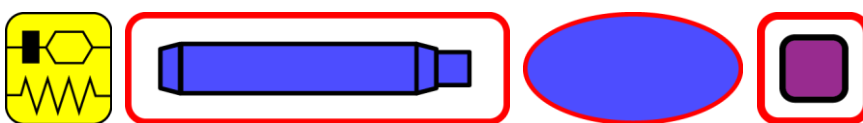
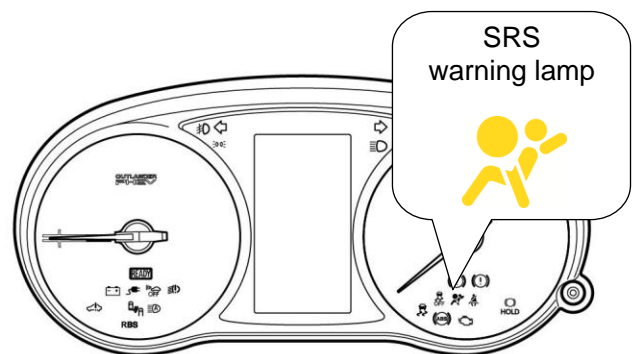
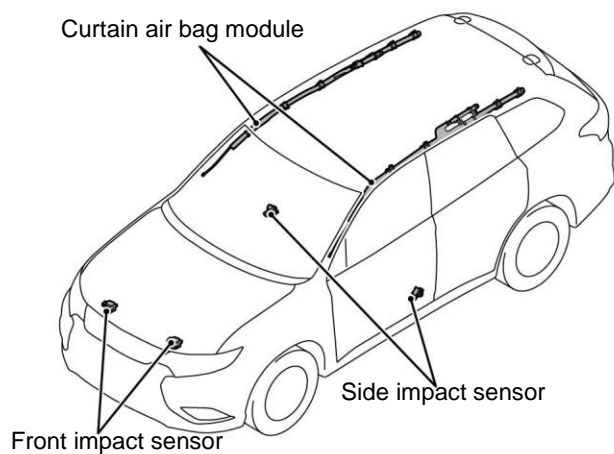
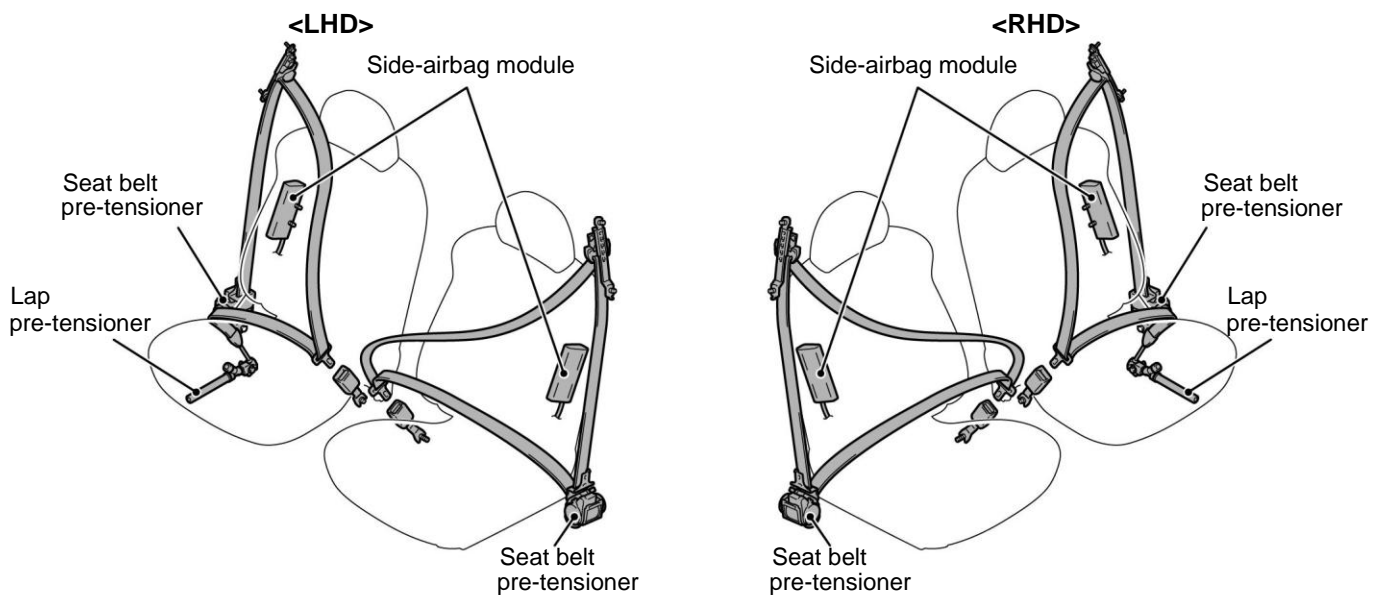
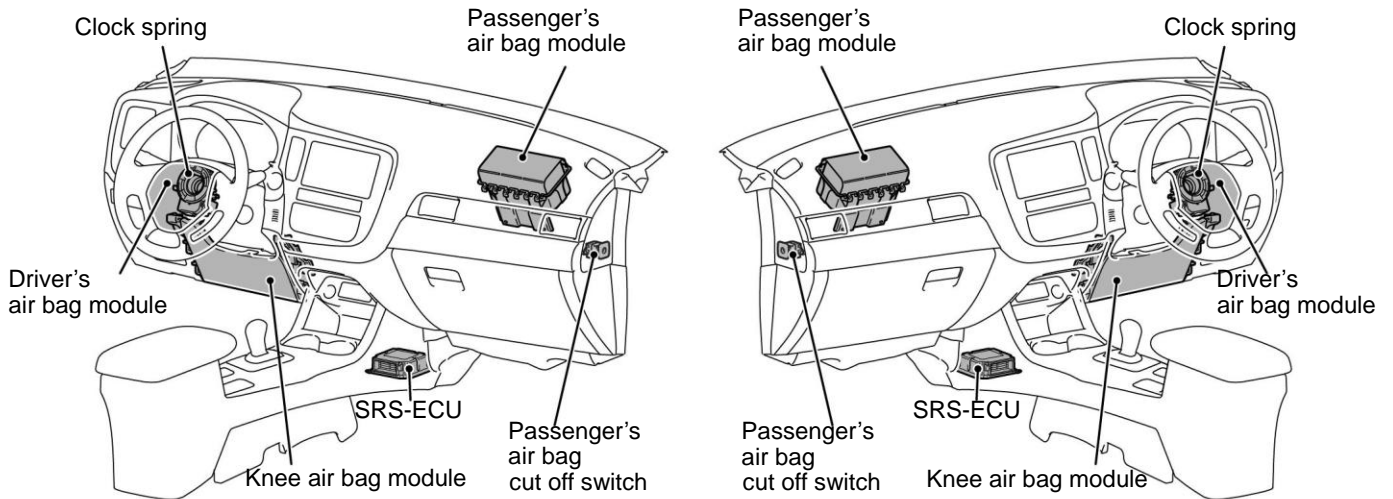

*: Refer to "10" for the explanation of pictogram

4. Vehicle dimensions

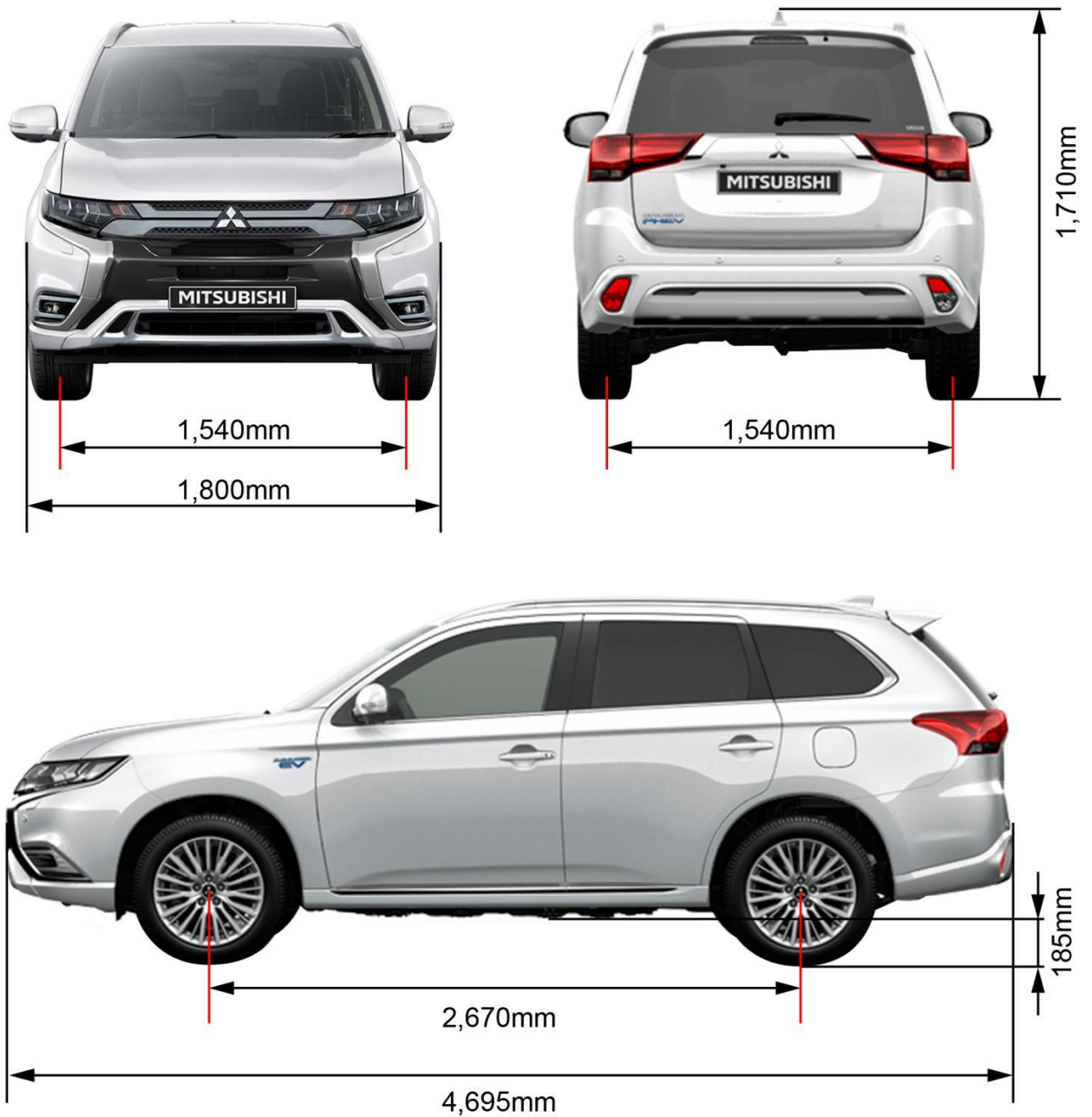

Vehicle weight 1,890 – 1,965kg*

* : Differs on the model, the vehicle weight will change.

2. Immobilisation / stabilization / lifting

1. How to determine if vehicle is ON / OFF.

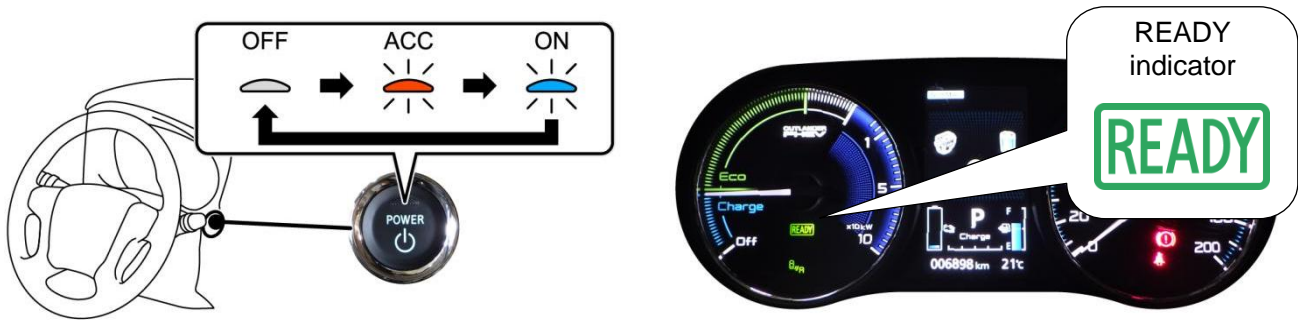

*: Refer to "10" for the explanation of pictogram

2. Support positions for Jack and Lift

⚠ CAUTION;

- Be sure to support the specified locations only. Otherwise, deformation of vehicle may occur.

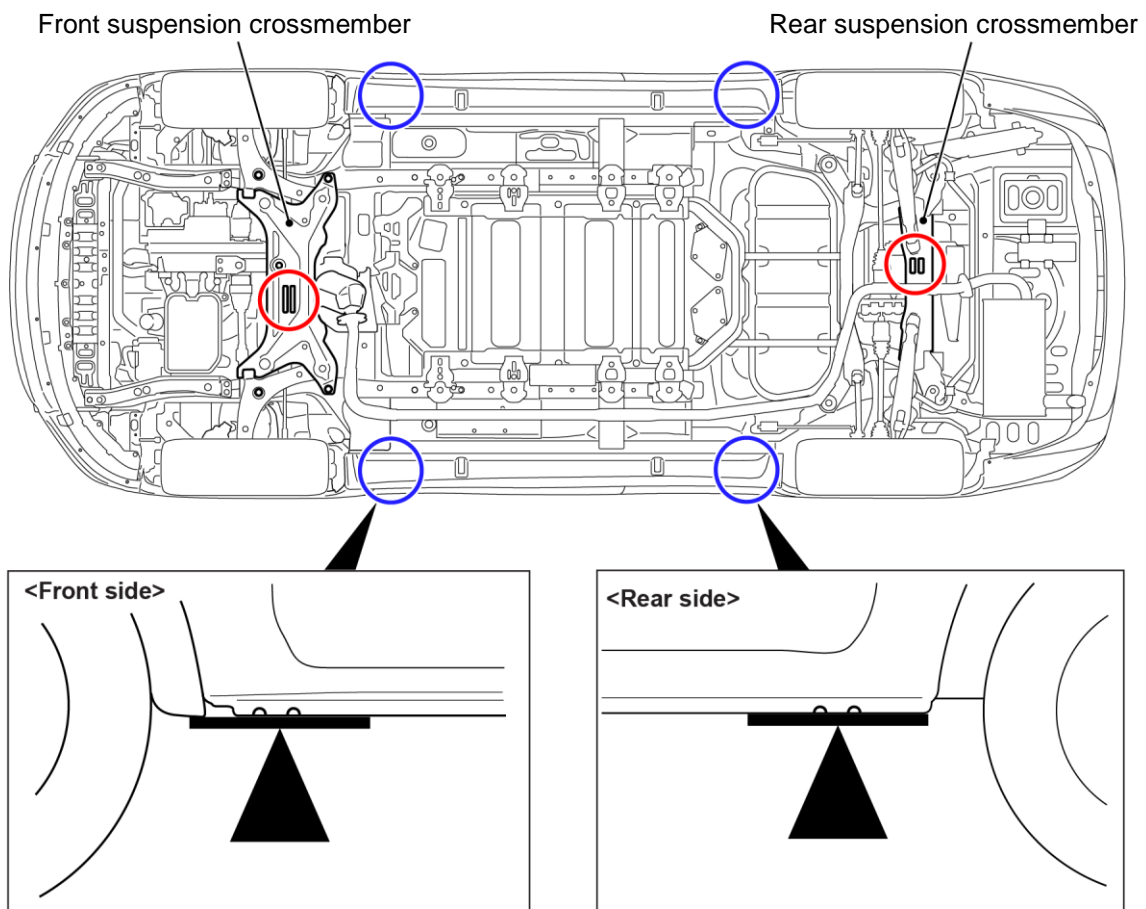

○:Support position for Garage Jack ○:Support position for Jack or Axle stands or Lift

3. Disable direct hazards / safety regulations

If the following systems are required to operate, disconnect the 12V auxiliary battery after the operation.

1. Electric power windows / Door lock

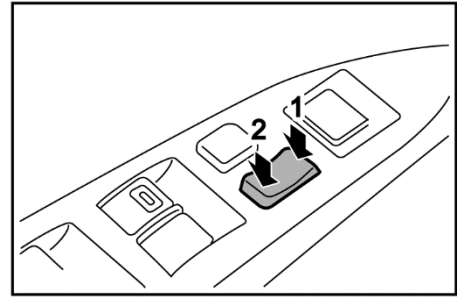
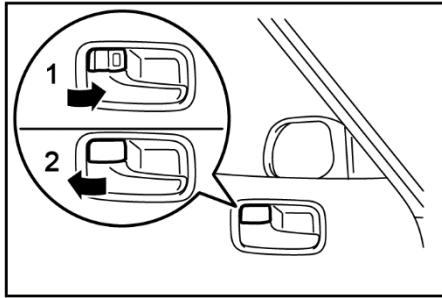
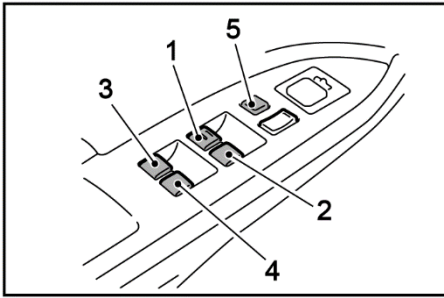

1 : Driver's door window
 2 : Front Passenger's door window
 3 : Rear left door window
 4 : Rear right door window
 5 : Window lock switch

1 : Lock
 2 : Unlock

* It is described based on the LHD. RHD is to invert the LHD.

2. How to open hood

- 1) Pull the release lever towards you to unlock the hood.
- 2) Raise the hood while pressing the safety lock.
- 3) Support the hood by inserting the support bar in its slot.

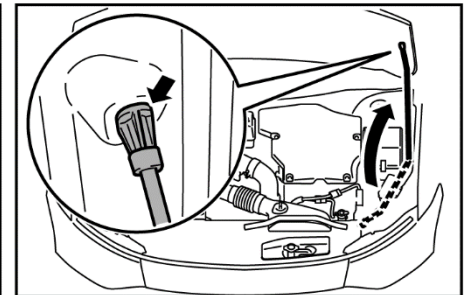
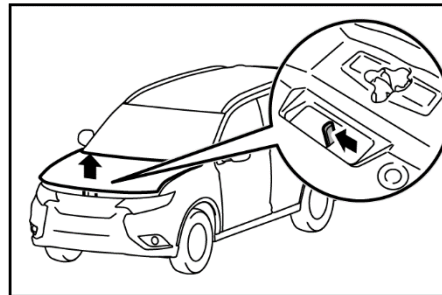
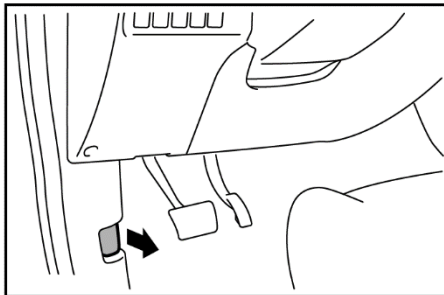

3. How to open tailgate

Unlocking the tailgate, push the tailgate open switch (A) and pull up the tailgate.

Electric tailgate can be auto opened by pressing the open switch (B).

The electric tailgate can be closed by pressing the close switch (C) on the inside of the electric tailgate.

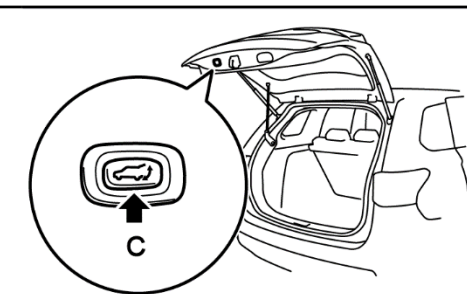
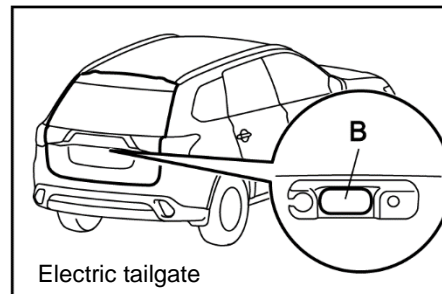
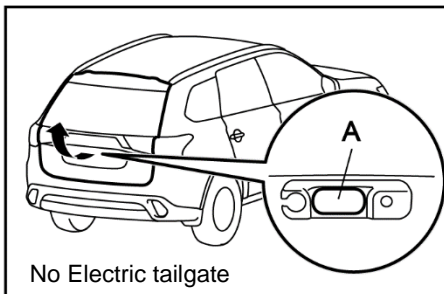

4. Inside tailgate release

The inside tailgate release is designed to provide a way to open the tailgate in the case of a discharged auxiliary battery.

- 1) Open the lid (A) inside of the tailgate.
- 2) Move the lever (B) to push out on the tailgate to open it.

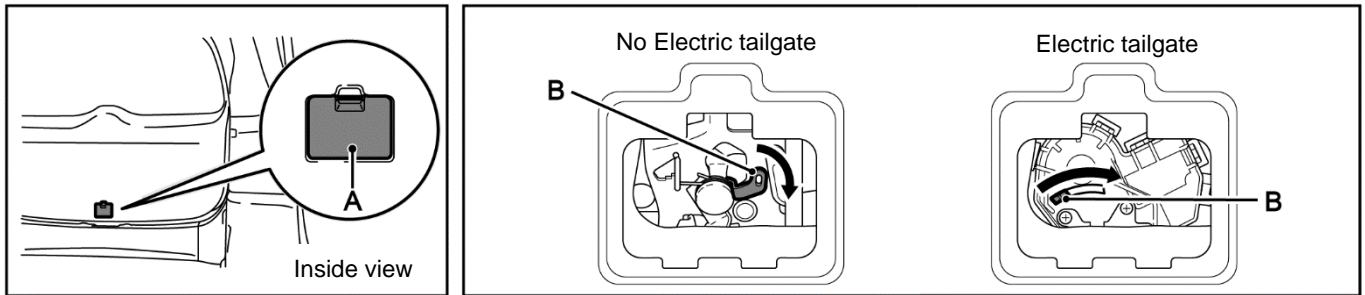

5. How to disconnect the 12V auxiliary battery negative terminal

Use an open end wrench (10 mm) to disconnect the negative terminal of the 12V auxiliary battery according to the procedure below, and then wrap a plastic tape around the disconnected negative terminal.

Shut down the SRS air bag system circuit by disconnecting the negative terminal of the 12V auxiliary battery.

- 1) Pull up the strap on the luggage floor box.
- 2) Remove the service lid of the 12V auxiliary battery.
- 3) Disconnect the 12V auxiliary battery negative terminal.

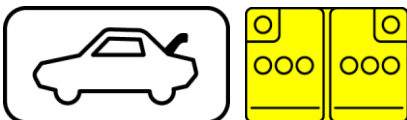
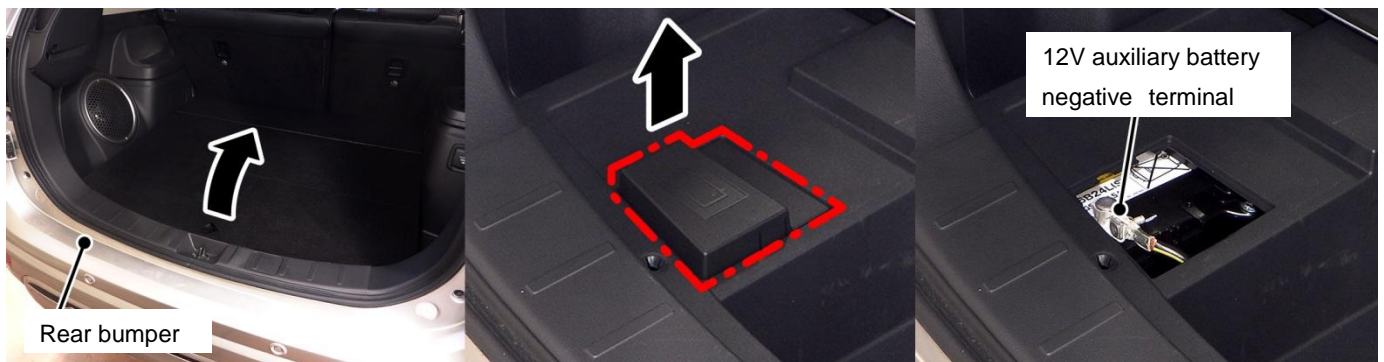

*: Refer to "10" for the explanation of pictogram

6. How to disconnect the "Power unit control" fuse

Remove "Power unit control" fuses (10A in the Picture below) from the engine compartment fuse box.

If you cannot locate this fuse, remove all fuses and relays in the fuse box.

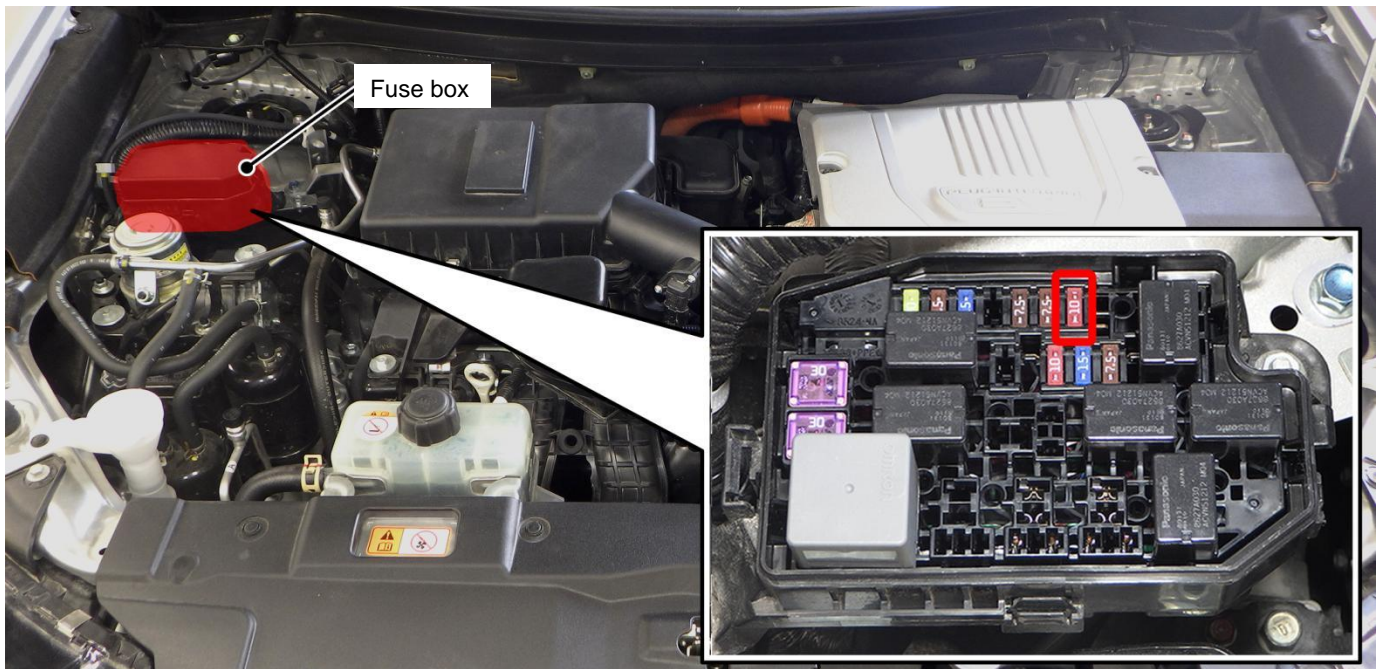

*: Refer to "10" for the explanation of pictogram

7. How to shut down High voltage (pull out the service plug)

- 1) Wear Personal Protective Equipment (PPE) and observe the procedure below to remove the service plug. Pulling out the service plug will shut down the high voltage circuit in the drive battery.
- 2) Remove the service lid cover in the footwall under the middle of the second seat. (four clips)
Use an open end wrench (10mm) to remove the service lid. (four nuts)



WARNING;

Always wear Personal Protective Equipment (PPE) when pulling out the service plug.



- 3) Wear Personal Protective Equipment (PPE) and remove the service plug.
 1. Release the lock lever on the service plug.
 2. Raise the service plug lever.
 3. Remove the service plug by pulling it upward.

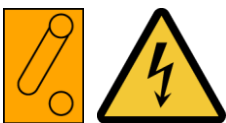

*: Refer to "10" for the explanation of pictogram

4. Access to the occupants

Failure to follow these instructions when performing a rescue may result in serious injury such as electric shock. Do not touch high voltage cable or components. Isolate high voltage circuits as necessary.

⚠️ WARNING;

Use insulating Personal Protective Equipment (PPE) (Rubber insulating gloves, Rubber soled insulating shoes: rated to a minimum of 400V voltage resistance) when you may touch the vehicle body directly or indirectly.



⚠️ CAUTION;

- When the 12V auxiliary battery is disconnected or removed, do not close the tailgate. If you close it once, you cannot open it again.
- The electric tailgate system will also be inoperative when the 12V auxiliary battery is disconnected.
- The electric parking brake system will also be inoperative when the 12V auxiliary battery is disconnected.

1. Windows

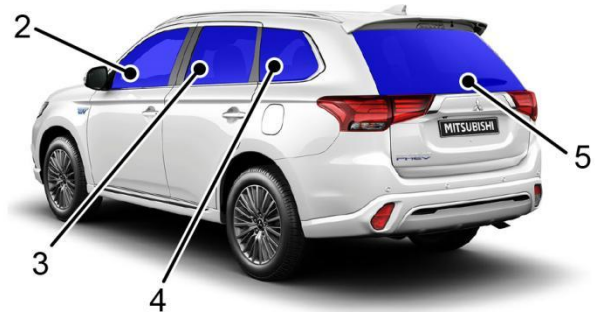
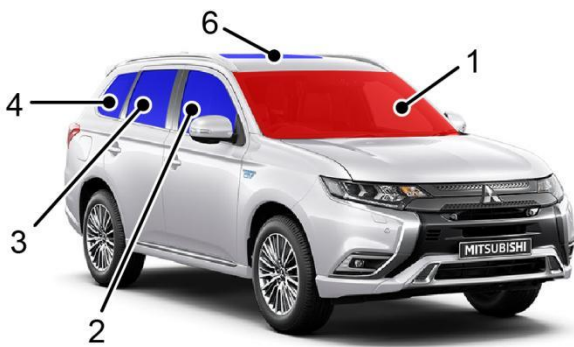

1 : Laminated glass
2 – 6 : Tempered glass

2. Adjustment seat and steering wheel

Seat

<Manual seat type>

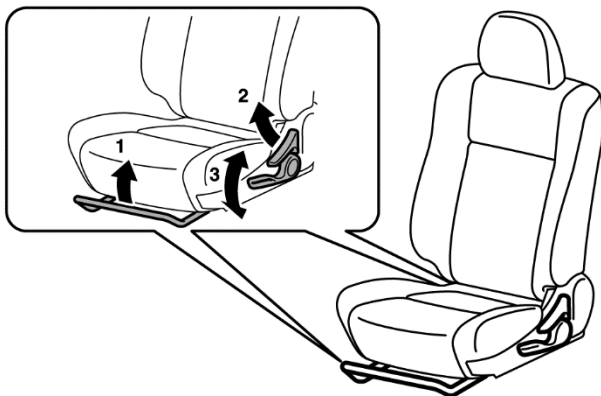

1 : To adjust forward or backward
2 : To recline the seatback
3 : To adjust seat height (driver's side only)

<Power seat type>

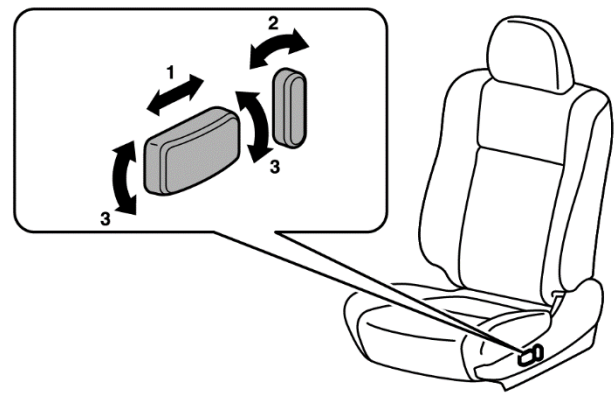

1 : To adjust forward or backward
2 : To recline the seatback
3 : To adjust seat height



*: Refer to "10" for the explanation of pictogram

Steering wheel

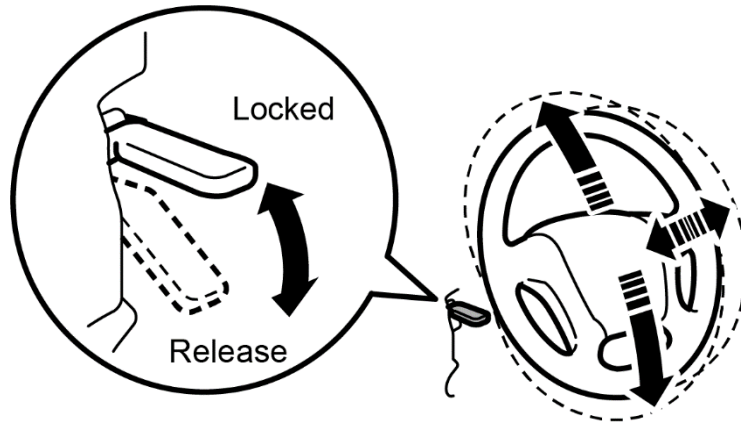

*: Refer to "10" for the explanation of pictogram

3. High-tensile and Ultra-high-tensile steel panels location

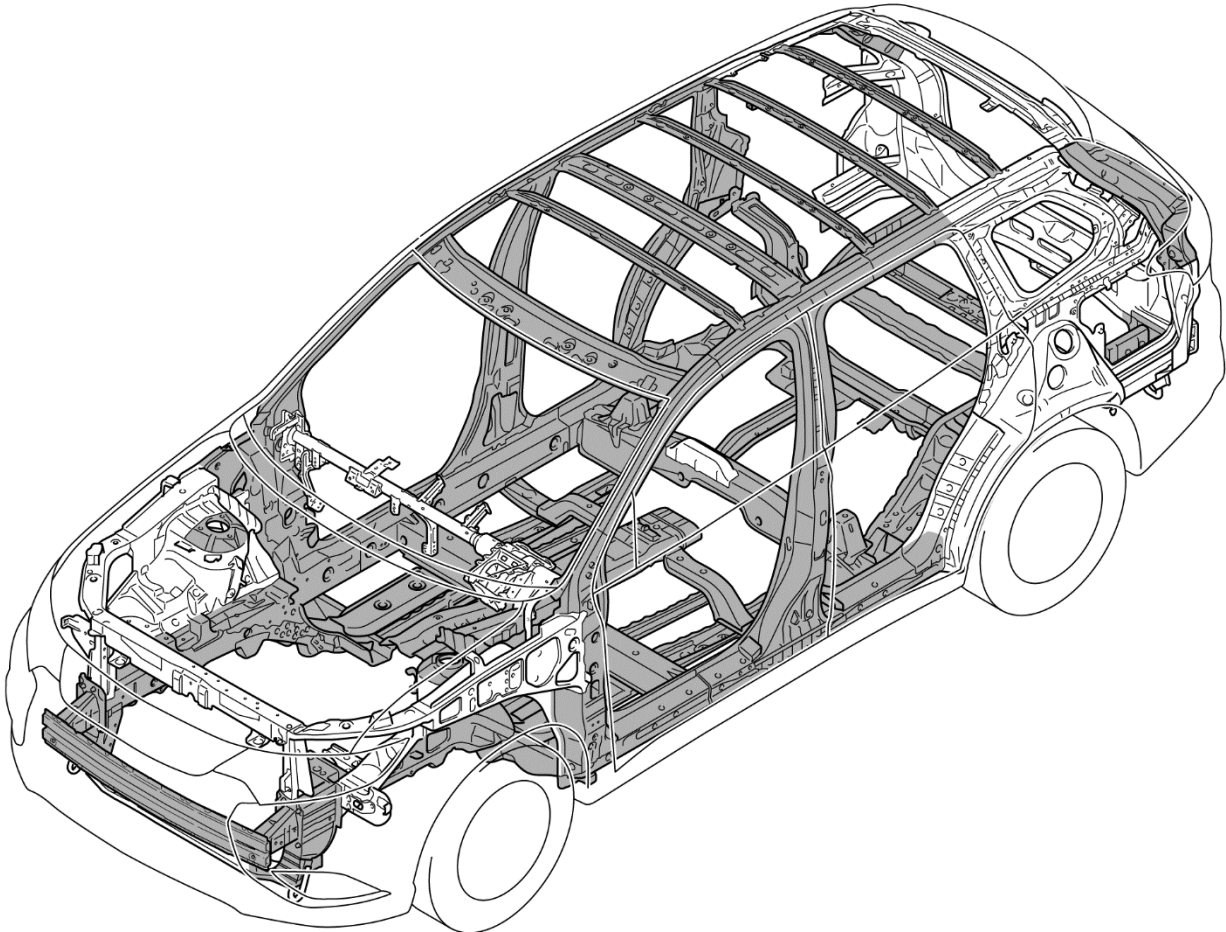

■: High-tensile and Ultra-high-tensile steel panels

4. Vehicle CUT Zones

It is necessary to cut the vehicle body and immediate rescue is essential or the orange-coloured high voltage cables are exposed

- Preliminary confirmation

Read this page and "2. High-voltage component and wiring harness location" before cutting the vehicle body.

⚠ WARNING;

- Use a hydraulic cutter or a suitable tool which does not generate sparks to cut the vehicle body. If you fail to do this, you or the passengers may be seriously injured.
- Never touch any exposed orange-colour high voltage wiring cables (cutoff or break a plastic jacket), or the portions shown in the figure.
- NEVER cut the drive battery.

	<p><u>Risk of high voltage shock</u> Never cut this area in vicinity of the high voltage components and cables as an electric shock may occur.</p> <p><u>Risk of airbag deployment</u> Do not cut this area because there is risk that an airbag may be deployed due to a short circuit or an impact caused by the accident. If an airbag has already been deployed, this area can be cut. If at least one minute has elapsed after disconnecting the negative terminal of 12V auxiliary battery or turning off the ignition switch, this area can be also cut.</p>
	<p><u>CUT ZONE</u></p>



← Front of vehicle

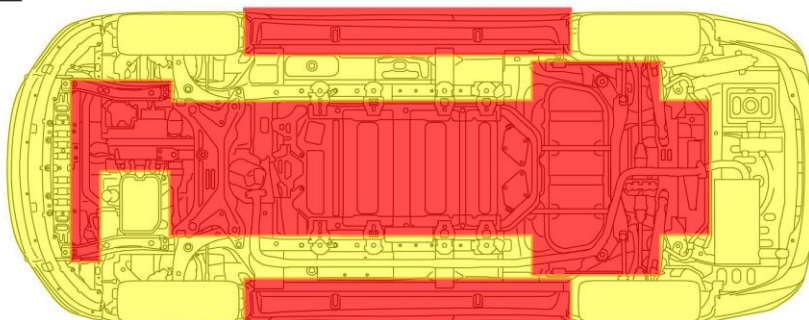

Bottom view

5. Stored energy / liquids / gases / solids

Fluids / gases used in this vehicle

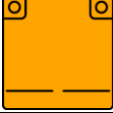
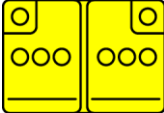
	Capacity & Type	Colour
Fuel tank (Petrol) 	45 liters	Light orange
Li-ion drive battery 	13.8 kWh	Clear & colourless
12V auxiliary battery 	36 Ah	Clear & colourless
Engine oil	4.3 liters (Oil pan) 0.3 liters (Oil filter)	Dark brown
Engine coolant	6.5 – 7.5 liters	Blue-green
Rear Motor coolant	6.5 liters	Blue-green
Brake fluid	As required	Clear & colourless
Front Motor fluid	2.2 liters	Red
Transaxle fluid	4.31 liters (Front : 3.46 liters / Rear : 0.85 liters)	Red
Refrigerant (air conditioner)	HFC-134a* : 520 – 560g HFO-1234yf : 495 – 535g	Non colour

* : Vehicles for Ukraine



WARNING;
 The battery assembly cover should never be breached or removed under any circumstances, including fire. Doing so might result in severe electrical burns, shock or electrocution.

*: Refer to "10" for the explanation of pictogram

Drive Battery information

Drive battery

- It is the battery to operate the motor and the air conditioning. In addition to the drive battery, OUTLANDER PHEV has the auxiliary battery to operate lamps, wipers, etc.
- Compact, light-weight lithium ion battery with high energy density is used for the drive battery.

The risk in normally use

- The Plug-in Hybrid EV System uses high voltage up to **DC 300V**. The system can be hot during and after starting and when the vehicle is shut off. Be careful of both the high-voltage and the high temperature. Follow the warning labels that are attached to the vehicle.
- Always assume the high voltage battery and associated components are energized and fully charged.
- Never perform servicing and rescue when READY indicator is illuminating or when the charging indicator is illuminating or flashing because the high-voltage system is operating.

In case of a collision

- If you detect leaking fluids, sparks, smoke, flames, gurgling, popping or hissing noises originating from the high-voltage battery component, contact emergency services immediately. This may result in a fire.

- Physical damage to the vehicle or high voltage battery may result in immediate or delayed release of toxic and/or flammable gases and fire.

6. In case of fire

1. Vehicle fire

In case of vehicle fire, alert fire department immediately and start extinguishing the fire using the following procedures where possible.

 **CAUTION;**

Failure to follow these instructions may result in serious injury such as electric shock:

1) The drive battery is designed to prevent a substantial amount of electrolyte from leaking from the drive battery just in case it is broken.

2) The drive battery uses an electrolyte made of flammable "Carbonate ester solution of lithium salts".

When reacting with moisture in the air, this electrolyte generates acidic organic vapour which is harmful to human body.

3) Therefore, when handling this, please use appropriate Personal Protective Equipment (PPE) including mask for organic gas, solvent resistance gloves and eye protector and use appropriate caution.



*: Refer to "10" for the explanation of pictogram

2. Fire-extinguishing

 **WARNING;**

·Never use seawater or any water containing salt.

·Use water to extinguish the fire

1) By using fire extinguisher

Use a fire extinguisher which is suitable for flammable liquid and electrical equipment fires.

2) By using water

Use water not containing salt, such as tap water, well water or pond water.

DO NOT attempt to extinguish the fire with a small amount of water as it is dangerous.

A large volume of water, such as from a fire hydrant must be used. Unless a large volume of salt-free water is available, keep away from the vehicle fire and wait for fire department to arrive.



*: Refer to "10" for the explanation of pictogram

7. In case of submersion

1. Submerged Vehicle

If the vehicle is submerged or partially submerged, first pull the vehicle out of the crew and water.

Then shut down the high voltage system.

If the vehicle is submerged, the drive battery may generate flammable hydrogen gas.

If the vehicle is submerged, water may enter the drive battery.

WARNING;

- If water enters the driving battery, hydrogen gas may be generated.
- When seawater enters, a large amount of hydrogen gas is generated by rapid electrolysis due to salinity, which may cause a fire.
- If you after lift the vehicle, please open the windows and doors as there may be hydrogen gas in the car.

Rescue operation

Inspect the vehicle for damage.

If the vehicle is severely damaged, the drive battery is deformed, broken or exposed (or you cannot evaluate how severely the drive battery is damaged), wear insulated Personal Protective Equipment (PPE) and carry out the rescue operation while taking care not to touch the drive battery.



*: Refer to "10" for the explanation of pictogram

Necessary action after the rescue operation

- 1) Remove the "Power unit control" fuses. ([Refer to 3-4](#))
- 2) Remove the "Service plug". ([Refer to 3-5](#))

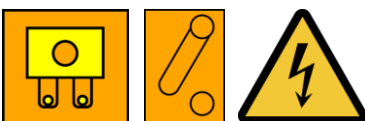

*: Refer to "10" for the explanation of pictogram

8. Towing / transportation / storage

1. How to Transport

Transport the vehicle on a flatbed truck or tow the vehicle with all wheels off ground.

⚠ WARNING;

Never tow the vehicle with front wheels and/or rear wheels on the ground. This may cause damage to the electric motors and transaxle.

⚠ CAUTION;

If the 12V auxiliary battery charging level is too low or the 12V auxiliary battery negative terminal is disconnected, you cannot move the selector lever from the P range.

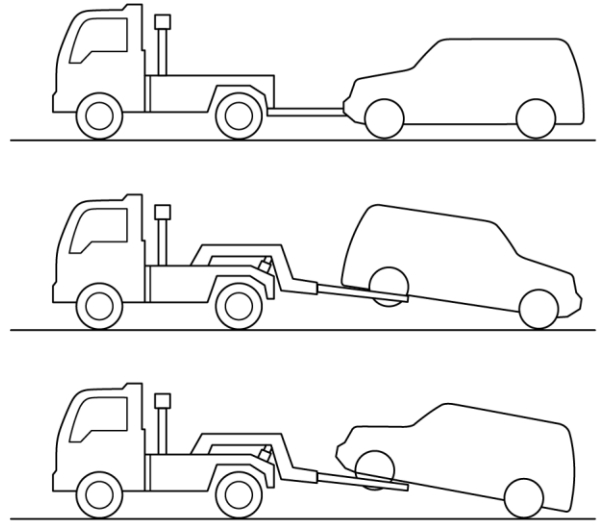
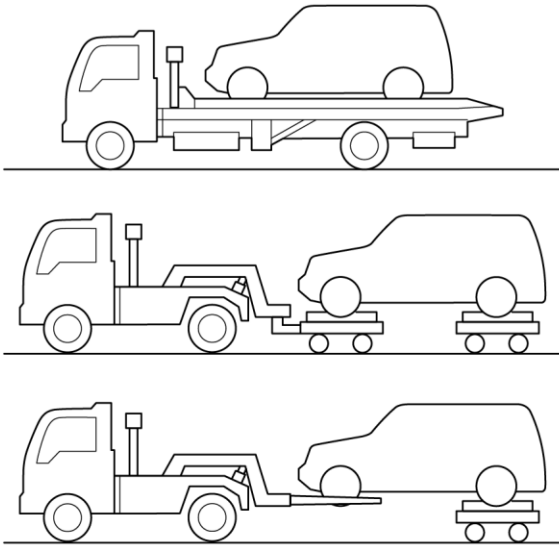

- The illustration shows examples only.
- When loading the vehicle on the truck, handle carefully to prevent further damage.

2. How to Towing (only in emergency)

- 1) Hook a towrope to the tow hook of the vehicle body.
- 2) Start the Plug-in Hybrid EV System.
If the Plug-in Hybrid EV System cannot be started, put the operation mode of the power switch in "ON".
- 3) Move the select position in "N" (Neutral) position.
- 4) Press down the Electric parking brake switch while depressing the brake pedal.
The indicator in the combination meter will turn off.
- 5) Turn on the hazard warning lamps to if required by law. (Follow the local driving laws and regulations.)
- 6) During towing make sure that close contact is maintained between the drivers of both vehicles, and that the vehicles travel at low speed.

⚠ WARNING;

If the vehicle is towed with the operation mode in "ON" without starting the Plugin Hybrid EV System, the auxiliary battery may be fully discharged during towing. In this case, the brake performance becomes very poor and the steering wheel becomes very heavy.

⚠ CAUTION;

- For vehicle equipped with the Adaptive Cruise Control system (ACC) and Forward Collision Mitigation system (FCM), stop these systems to prevent an unexpected accident or unexpected operation during towing.
- When the vehicle is to be towed by another vehicle with all the wheels on the ground, make sure that the towing speed and distance given below are never exceeded, avoiding damage to the transaxle.

•Towing speed: 30 km/h (19 mph)

•Towing distance: 30 km (19 miles)

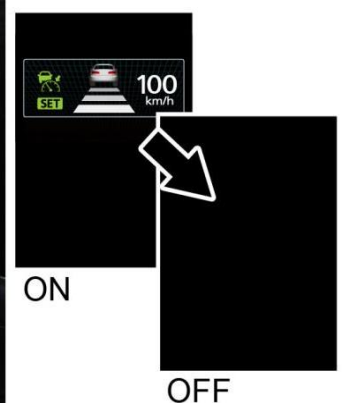
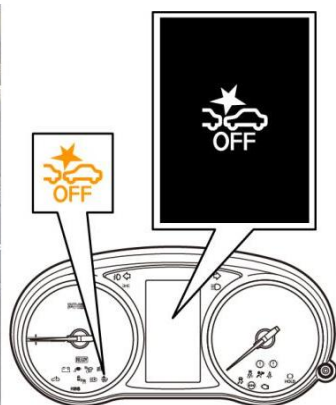
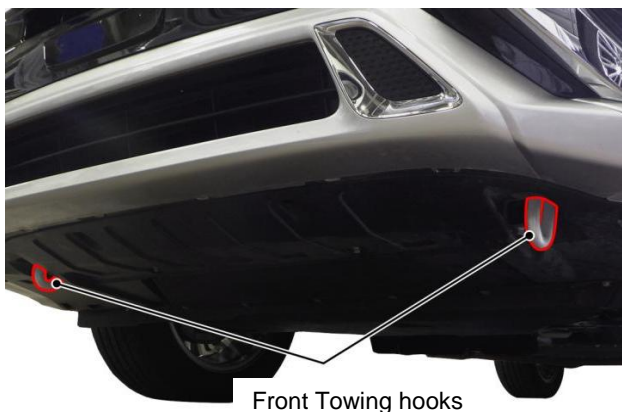

To turn off FCM

You can switch the system from ON to OFF if you hold the "FCM ON/OFF" switch pressed when the operation mode is set to "ON".

When you turn off the system, the following message appears on the screen and the  indicator comes on.

To turn off ACC

Press the "ACC ON/OFF switch" when ACC is in the 'ON state' to turn off ACC.

3. How to release the electric parking brake manually

⚠ CAUTION;

•Releasing the electric parking brake manually is limited to an emergency case.

- 1) With the vehicle parked, move the selector lever to P position, then chock the wheels.
- 2) Disconnect the 12V auxiliary battery negative terminal.

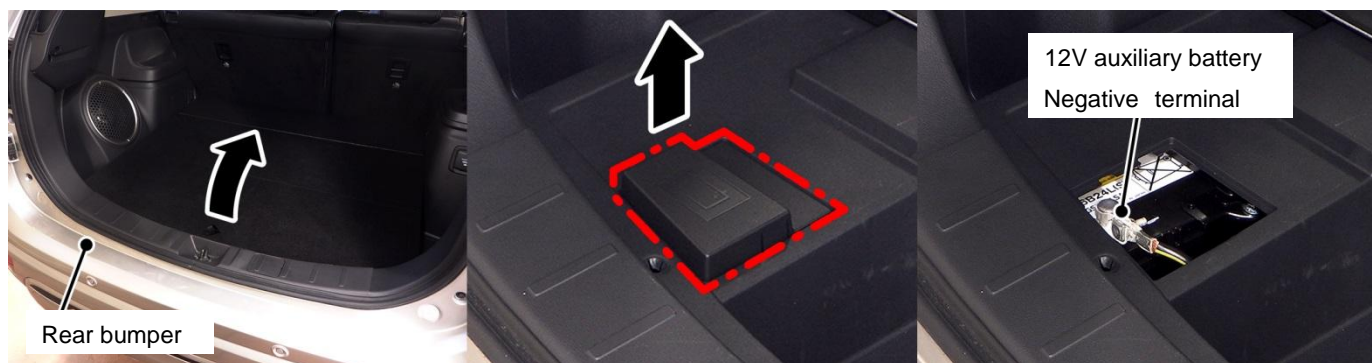

⚠ CAUTION;

•If signs of dirt or water are found around the connector, clean it thoroughly. Ensure that no foreign materials intrude into the connector.

- 3) Disconnect the wiring harness connector from the electric parking actuator.
- 4) Remove the two bolts to remove the electric parking actuator from the rear brake caliper assembly.

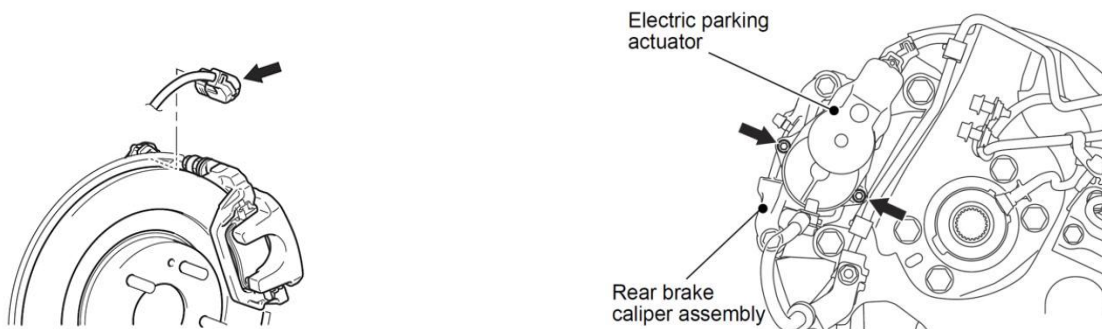

- 5) Insert a hexagonal wrench (6 mm) to the rear brake caliper assembly, and then turn the wrench clockwise 2 turns.

⚠ WARNING;

•Depress the brake pedal before releasing the parking brake. If not, the vehicle will start to move as soon as you release the parking brake.

⚠ CAUTION;

•The brake fluid may overflow.

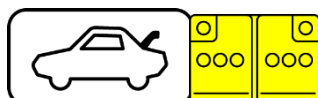
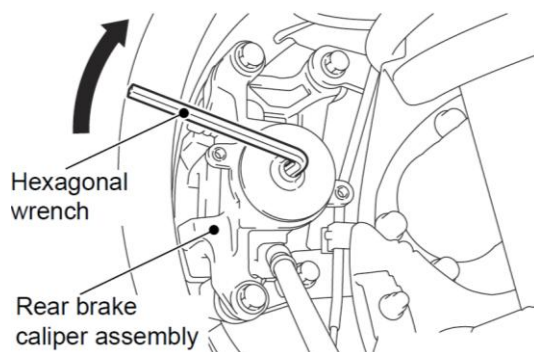

*: Refer to "10" for the explanation of pictogram

9.Important additional information

Discharge measures

If the drive battery is damaged or the vehicle is submerged, perform discharge measures as follows.

⚠ WARNING;

- Failure to follow these instructions may result in serious injury such as electric shock.
- If electrolyte leaks from the drive battery, or if water gets inside the drive battery, rapid electrolysis may generate hydrogen gas and ignite.
- If water gets inside the drive battery, vigorously inject water (water that does not contain salt water such as tap water, well water, pond water, seawater etc.) and perform discharge treatment.
- Vehicles injected with water should be stored outdoors in a well ventilated area. Open the windows or doors as there is a risk of hydrogen gas filling the vehicle compartment.
- It takes about 84 hours (3.5days) to complete the discharge procedure. Please note that it may cause smoke and fire due to hydrogen gas.
- Since the injected water is converted to an aqueous solution containing metals such as P (Phosphorus) and Li (Lithium), please dispose of it properly as an industrial waste according to local regulations when.

How to discharge measures by in pool

If the drive battery is severely damaged, it is necessary to discharge the drive battery to avoid electric shock and fire.

Perform the discharge measures procedure according to the following procedure.

- 1) Set up an easy set pool in the size of approximately.
550 cm x 250 cm x 100 cm (length x width x height)
- 2) If there is a risk of water leakage from the easy set pool, place a thick plastic sheet under the pool.
- 3) Use a forklift or similar equipment to place the vehicle in the centre of the pool.

⚠ CAUTION;

- Place the vehicle horizontally or slightly tilted forward. If you fail to do this, the vehicle may not be submerged up to the required level.

- 4) Turn off the Power switch by pressing it. Remove the 12V auxiliary battery negative terminal.
- 5) Remove the service lid cover in the footwell under the middle of the second seat. (four clips)
- 6) Use an open end wrench (10mm) to remove the service lid. (four nuts)



⚠ WARNING;

Always wear Personal Protective Equipment (PPE) when pulling out the service plug.



- 7) Wear Personal Protective Equipment (PPE) and remove the service plug.
 1. Release the lock lever on the service plug.
 2. Raise the service plug lever.
 3. Remove the service plug by pulling it upward.

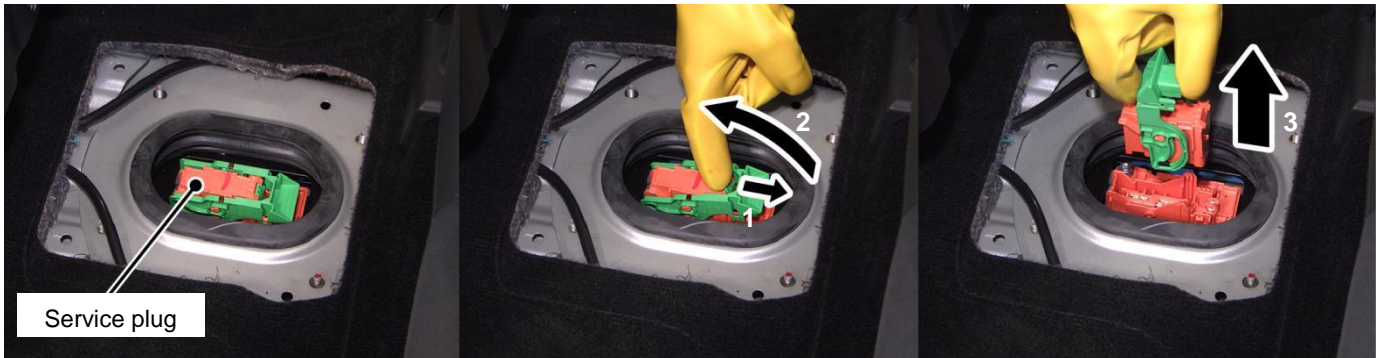

- 8) Open the windows or doors.
- 9) Make sure to use water not containing salt, such as tap water, well water or pond water, to prevent harmful reactions.

Keep pouring a sufficient volume of water, such as from a fire hydrant or a tap. DO NOT attempt to extinguish the fire with a small amount of water. If a small amount of water contacts the inner portion of the Main drive lithium-ion battery, a short circuit can occur causing the release of toxic gas.

Required water level: Keep pouring water until the entire floor is submerged (a minimum required depth of 50 cm is achieved; see illustration below).

This water level is considered deep enough for the main drive lithium-ion battery to be completely submerged in water.

Maintain this water level for at least 84 hours (3.5 days) with the drive battery submerged in water. Check the water level periodically. When the water level is lower than the specified level, add fresh water.

Reference) Water filling amount in the easy set pool.



Until the entire floor is submerged.
(Until the service plug is submerged completely)

How to discharge measures by water injection

- 1) Move the vehicle to an outside well-ventilated area.
- 2) Turn off the Power switch by pressing it. Remove the 12V auxiliary battery negative terminal.
- 3) Remove the service lid cover in the footwell under the middle of the second seat. (Four clips)
- 4) Use an open end wrench (10mm) to remove the service lid. (four nuts)



⚠ WARNING;

Always wear Personal Protective Equipment (PPE) when pulling out the service plug.



- 5) Wear Personal Protective Equipment (PPE) and remove the service plug.
 1. Release the lock lever on the service plug.
 2. Raise the service plug lever.
 3. Remove the service plug by pulling it upward.

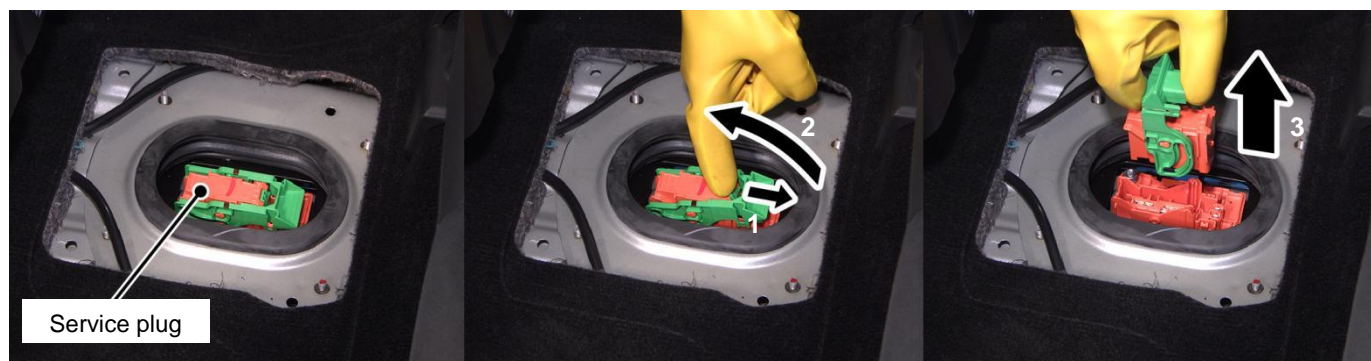

- 6) Place a recovery tray of the injected water under the vehicle.

- 7) Fill with water that does not contain salt, such as tap water, well water or pond water through the plug opening on the service lid fully. Then continue pouring at a rate of 3 liter/min for 30 minutes to remove foreign materials from the inside of the battery.

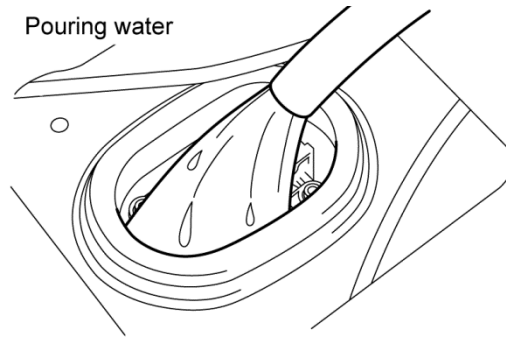

Use a suitable tray to collect the poured water through the drain plug at the bottom of the drive battery. (You cannot see the drain plug because it is covered with the battery protector as shown)

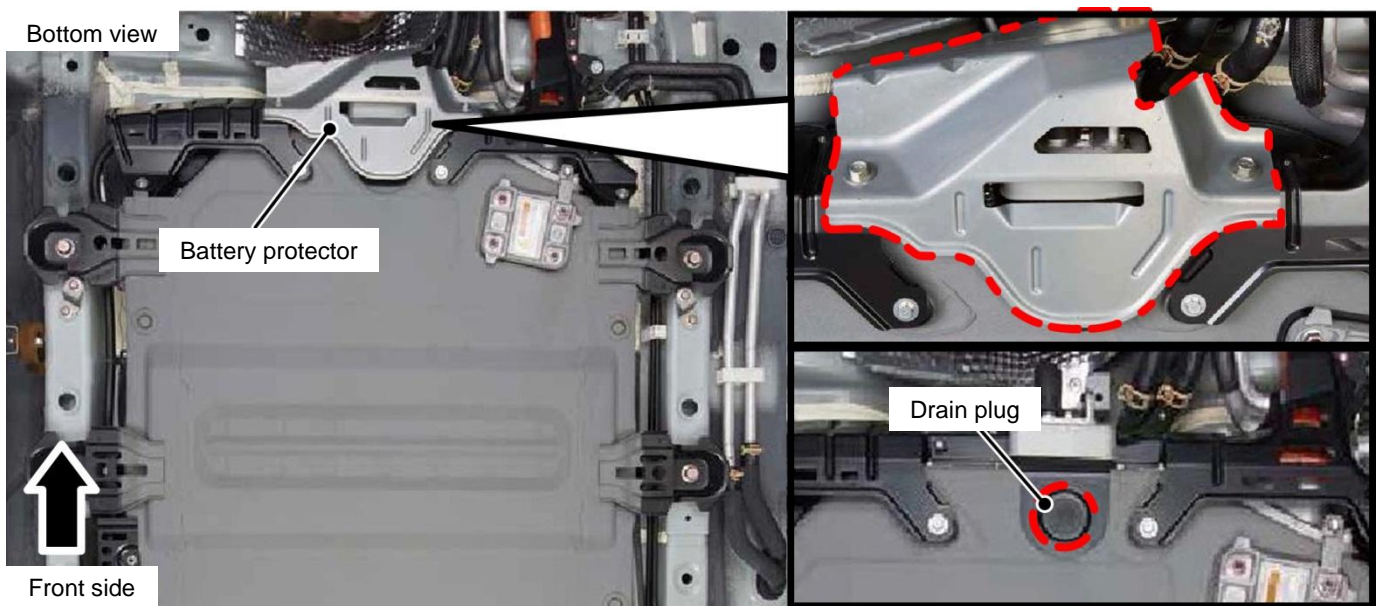

⚠ CAUTION;
the main drive lithium-ion battery must be properly disposed of as industrial waste according to local regulations.

- 8) Wait for approx. 20 minutes until the water has drained completely.
9) Raise the vehicle and then use a 12-mm wrench to remove the battery protector.

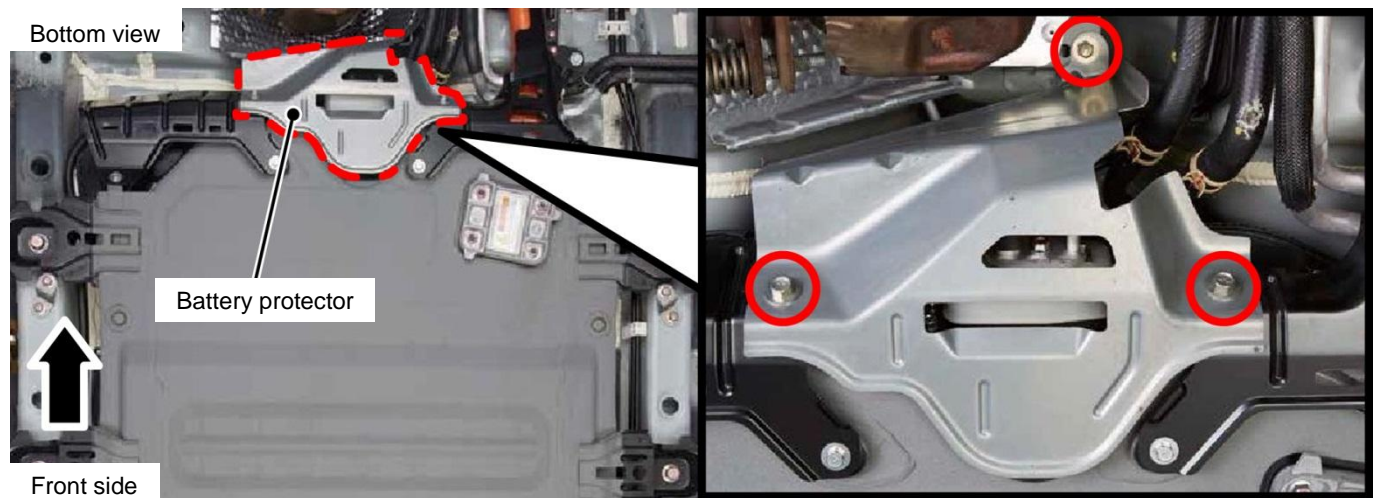

- 10) Place the drain plug gasket (MB992947) and the drain plug cover (MB992946) in that order on the bottom of the drain plug. Then hold them against the bottom of the battery using a jack

MB992946
Drain plug cover



MB992947
Drain plug gasket

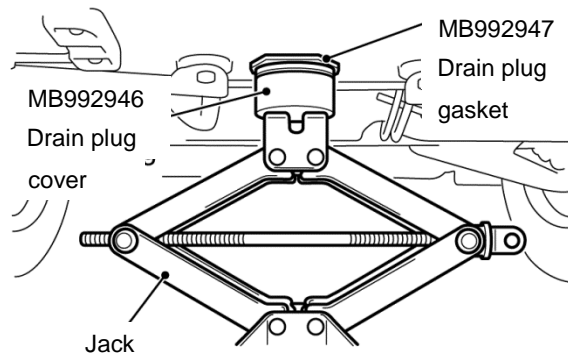
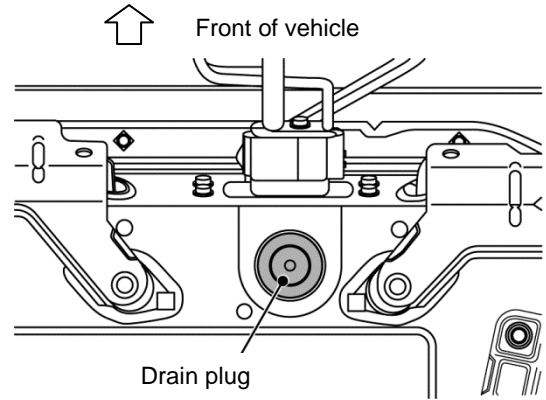
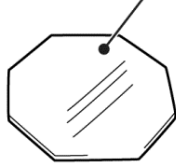

Reference) · MB992947: Drain plug gasket

(Silicone rubber sheet: approx. 70 x 70 x 3 mm) (2.75" x 2.75" x 1.25").

· MB992946: Drain plug cover (Base for the silicone rubber sheet)

* [Drain plug gasket \(MB992947\) and Drain plug cover \(MB992946\)](#) is Mitsubishi Motors special tools

- 11) Fill with water that does not contain salt, such as tap water, well water or pond water through the plug opening under the service lid into the main drive lithium-ion battery until the water overflows.
- 12) Keep the drive battery filled with water for at least 84 hours (3.5 days). Electrolysis of water produces hydrogen inside the battery for that period. Keep the vehicle in an outside well-ventilated area with all windows or doors and tailgate open.

How to drain the remaining water

On the following to collect the water.

Pool	Wait for at least approx. 84 hours (3.5 days), and then drain water from the pool.
Water Injection	Remove the special tools from the bottom of the drain plug, and wait until the water has drained completely. Place a suitable tray under the drain plug to collect the drained water.

- 1) Use an open end wrench (12mm) to remove the service hole lids on the bottom of the main drive lithium-ion battery and drain the main drive lithium-ion battery.

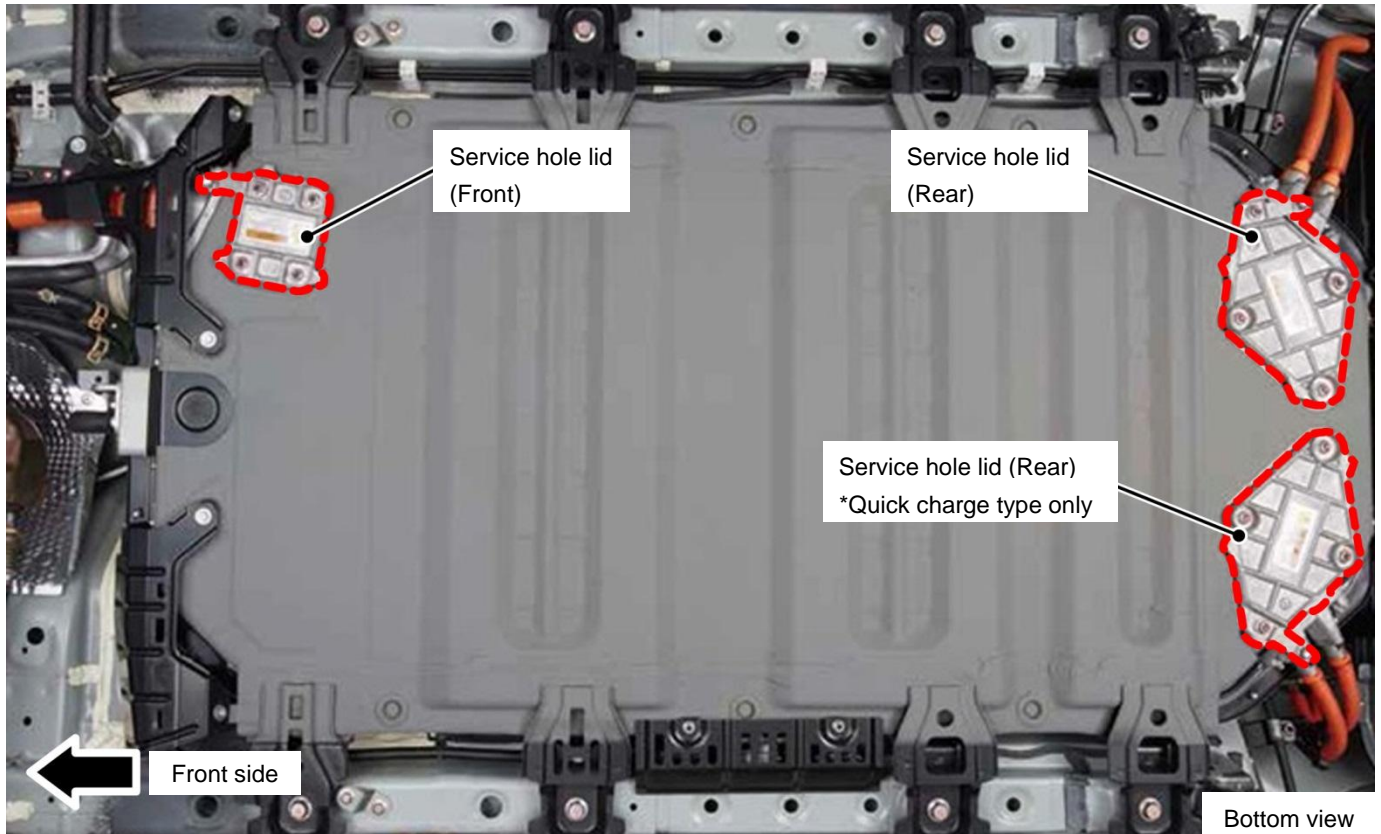



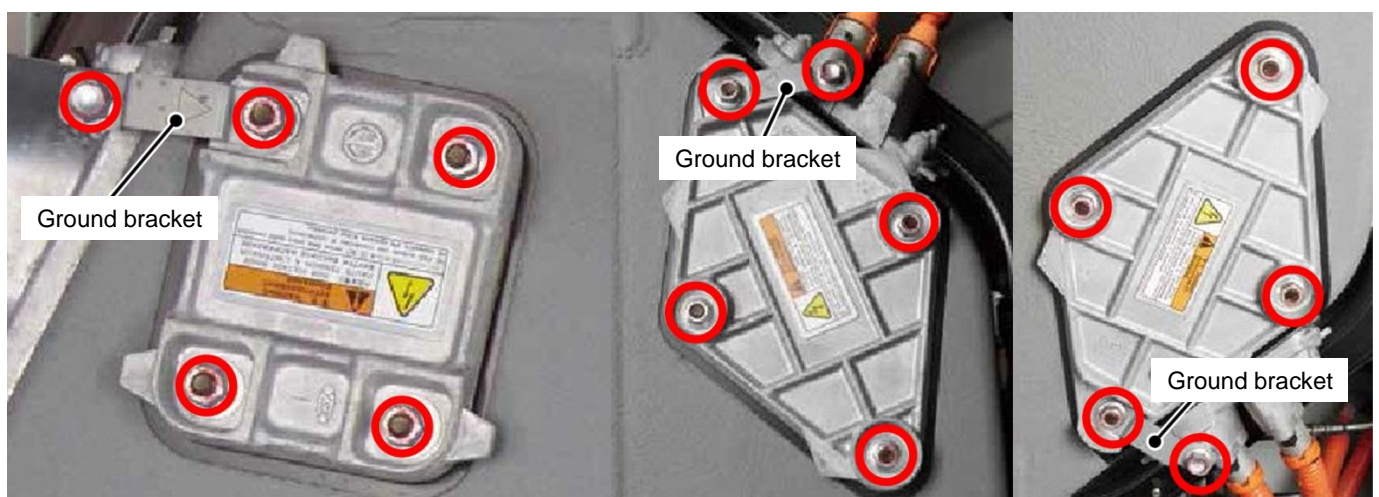







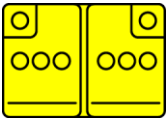



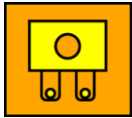
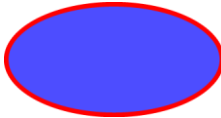



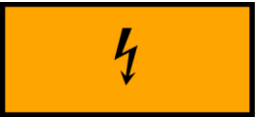



- 2) Remove the ground bracket.
- 3) Remove the service hole lid.



⚠ CAUTION;

The water drained from the drive battery shall be properly disposed of as an industrial waste according to local regulations.

10. Explanation of pictograms used

	12V auxiliary battery		SRS unit
	Power switch		Airbag inflator
	Fuse box disabling high voltage		Air bag
	Warning, Electricity		Seat belt pretensioner
	High voltage cable		Adjustment seat forward or backward
	High voltage component		Adjustment seat height
	Service plug		Steering wheel height adjustment
	Open Hood		Lifting point
	Open Tailgate		Fuel tank
	Use ABC powder to extinguish the fire		Use water to extinguish the fire
	Risk of flammability		Risk of an explosion
	Risk of damaging human health		Risk of corrosive material / substances

